

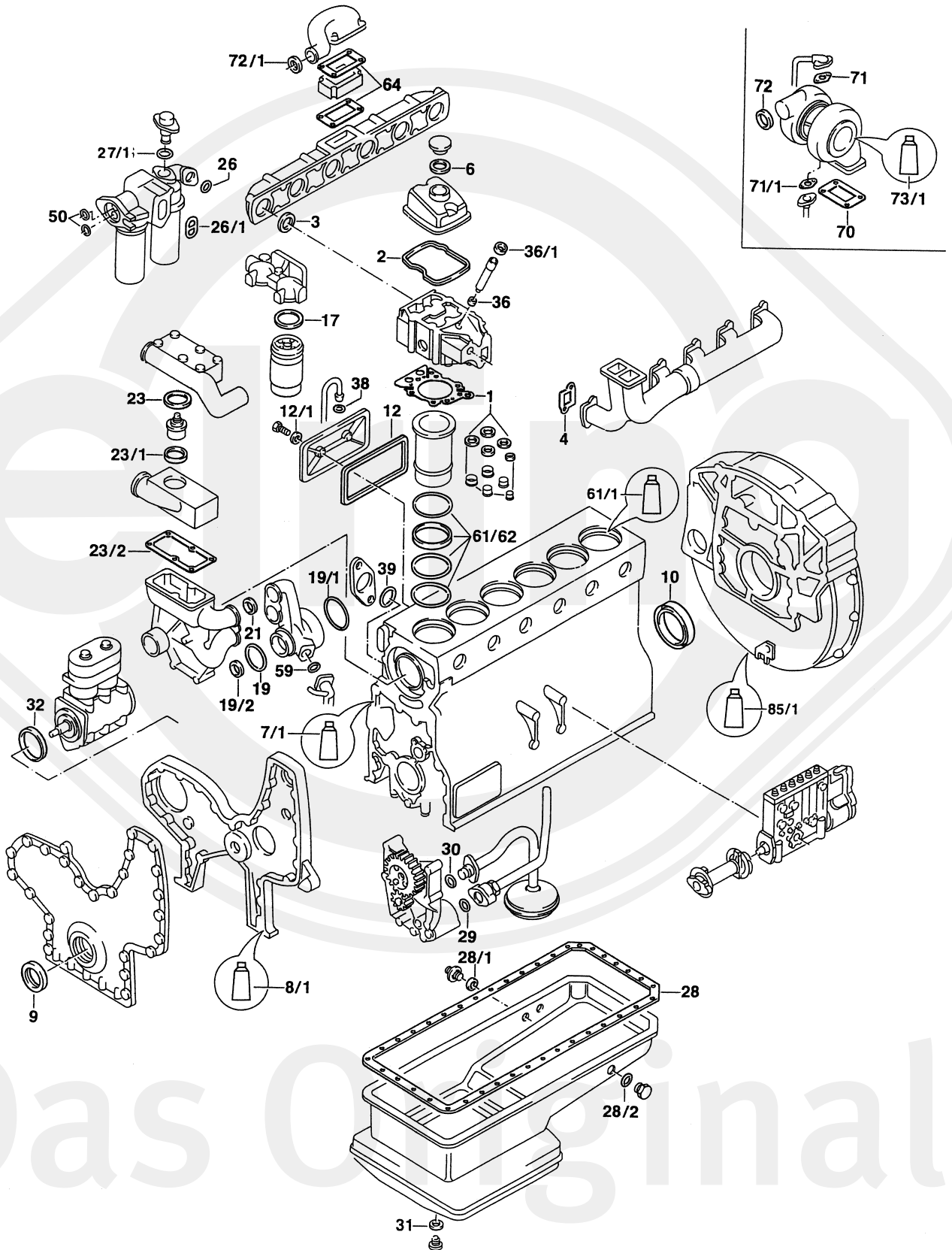

















Das Original

Volvo

































TD 122 | 123



 TD 122F/FA/FH/FK/FL/FR/FS
 TD 123E/ES

			#				
S ⊕ *	917.117	1x	-	-	-	-	F 12  314000 → N 12  306000 → 
ES ⊕	917.109	1x	-	-	-	-	-
CS *	755.648	1x	276 125-2	-	-	-	F 12  314000 → N 12  306000 →
CS *	108.325	1x	276 124-5	-	-	-	N 12 S
ZLBS	755.672	6x	270 950-9	-	-	-	-
AAS	087.352	1x	270 772-7	-	-	-	-
ZKHS	087.343	1x	275 554-4	-	-	-	-
1	755.621	6x	270 949-1	-	-	-	-
2	776.468	6x	424 692-2	-	-	-	-
3	088.056	6x	423 174-2	78,5x85,5x4,5 NBR A	-	-	-
4	527.319	6x	470 534-9	-	-	-	-
6	045.721	1x	940 096-1	42x47x3 NBR A	-	-	-
7/1	610.023	1x	1 161 231-4	310 ml		Dirko™ HT	
8/1	610.023	1x	1 161 231-4	310 ml		Dirko™ HT	
9	570.495	1x	424 983-5	85,7x114,3x13 AW/BS RD FPM	-	-	-
10	760.316	1x	20 441 697	155x180x15 AW/BS LD FPM	-	-	-
12	101.339	3x	469 823-9	-	-	-	-
12/1		6x	471 856-5	14,5x3 NBR RD	-	-	-
17	-	2x	6638 088-2	-	-	-	-
19		1x	925 257-8	89,5x3 NBR RD	-	-	-
21	206.650	3x	1 664 473-4	59,5x3 EPDM RD	-	-	-
22	-	-	-	-	-	-	-
22/1	-	-	-	-	-	-	-
23		1x	1 544 410-2	77,5x84x4,6 EPDM PR	-	-	-
23/1	754.854	1x	1 544 710-5	53,1x67,58x6,35 PTFE	-	-	-

 TD 122F/FA/FH/FK/FL/FR/FS
 TD 123E/ES

			#	  	
23/2		1x	423 352-4	-	-
26		1x	949 659-7	34,2x3 FPM RD	-
26/1		1x	469 486-5	FPM	-
27/1		1x	949 659-7	34,2x3 FPM RD	-
28	477.030	1x	424 603-9	-	 
28	749.487	1x	478 505-1	-	 
28/1		1x	949 658-9	24,2x3 FPM RD	
28/2		1x	468 947-7	-	-
29	-	-	-	-	-
30		1x	470 383-1	25,3x33,3x5 FPM A	-
31	129.100	1x	18 677-5	22x29x1,5 CU A	-
32	-	1x	915 610-7	115x3,1 FPM RD	
36/1		6x	466 405-8	24x33x5 VMQ A	-
38		1x	421 158-7	29x35x5 NBR A	-
39		1x	949 657-1	22,2x3 FPM RD	-
59		1x	925 092-9	54,5x3 NBR RD	-
61		6x	470 922-6	140,5x2,4 FPM RD	-
61/1	036.164	1x	1 161 277-7	70 ml	 Dirko™ HT 
62		12x	470 190-0	142,6x5,8 FPM RD	
62	813.583	6x	424 833-2	142,6x5,8 FPM RD	
64	755.265	2x	424 618-7	-	-
70	753.238	1x	20 784 537	-	-
71	755.230	1x	420 641-3	-	-
71/1	753.262	1x	420 643-9	-	TD 122 F FH TD 123 E
71/1		1x	470 993-7	-	TD 122 FA FK FR FS FL
72	-	-	-	-	-
73/1	-	-	-	-	-
85/1	610.023	1x	1 161 231-4	310 ml	 Dirko™ HT 
90	-	48x	470 261-9	-	-