



Toyota | Daewoo |
Hyundai | Kia



Das Original

Online sealant adviser: Find the right product in 3 steps

Elring-Dichtmassenberater: In 3 Schritten zu Ihrem Produkt

Conseiller en pâtes à joint Elring: Trouvez le bon produit en 3 étapes

Asesor de pastas sellantes de Elring: Su producto ideal a tan solo 3 pasos

Il consulente sui sigillanti di Elring: In 3 passi al prodotto giusto

Asystent w doborze mas uszczelniających Elring. Znajdź właściwy produkt w 3 krokach



1 Toyota

- 6 1KR-FE → 2014
- 8 1KR-FE 2014 →
- 10 1CD-FTV
- 12 1NR-FE → 2015
- 16 1NR-FE 2016 →

2 Daewoo

- 20 F8CV

3 Hyundai | Kia

- 24 G4FA
- 26 G4FC
- 30 G4FD



YouTube

	#		
	478.930	04112-27071	Avensis, Corolla, Previa, Rav 4
	169.740	04112-22060	Allion, Auris, Avensis, Celica, Corolla, Isis, MR 2, Rav 4, Wish
	308.520	04112-0R180	Auris, Avensis, Corolla, Rav 4, Verso
	310.920	04112-0T011	Auris, Avensis, Corolla, Premio, Rav 4, Yaris
	486.000	04112-0J080	Ractis, Yaris
	428.310	04112-0T064	Allion, Auris, Avensis, Corolla, Verso
	717.520	04112-0N040	Auris, Corolla, IQ, Urban Cruiser, Verso, Yaris
	022.860	04112-11121	Corolla, Starlet
	318.540	-	Auris, Avensis, Corolla, Rav 4, Verso
	141.970	11115-22040	Allion, Auris, Avensis, Celica, Corolla, Isis, MR 2, Rav 4, Wish
	286.760	11115-26052-E0	Auris, Avensis, Corolla, Rav 4, Verso
	298.640	11115-37050	Allion, Auris, Avensis, C-HR, Corolla, Premio, Prius, Rav 4, Verso, Yaris
	286.630	11115-26052-C0	Auris, Avensis, Corolla, Rav 4, Verso
	286.750	11115-26052-D0	Auris, Avensis, Corolla, Rav 4, Verso
	141.990	11115-28020	Avensis, Camry, Rav 4
	354.210	11115-27011-D0	Avensis, Corolla, Previa, Rav 4
	169.750	11115-21030	Corolla, Prius, Yaris, Yaris Verso
	428.550	11115-27011-E0	Avensis, Corolla, Previa, Rav 4
	141.980	11115-23030	Yaris
	298.410	11115-47050	Auris, Corolla, IQ, Urban Cruiser, Verso, Yaris
	473.480	11115-23042	Ractis, Yaris
	197.720	11115-67040-05	4 Runner, Land Cruiser
	354.240	11115-28011	Avensis, Camry, Previa, Rav 4
	428.540	11115-27011-C0	Avensis, Corolla, Previa, Rav 4
	484.750	11115-40060	Aygo, IQ, Yaris
	708.040	11115-16121	Avensis, Carina, Celica, Corolla,
	707.951	11115-16150	Avensis, Carina, Corolla,
	574.220	11115-33021-E0	Yaris, Yaris Verso
	707.860	11115-11071	Corolla, Paseo, Starlet
	700.270	11115-33030E0	Auris, Corolla, IQ, Urban Cruiser, Verso, Yaris

1 KR-FE

Cylinders Zylinder Cylindres Cilindros Cilindri Cyliny	3	AYGO IQ YARIS	2005 - 2009 - 2015 2010 -
Capacity Hubraum Cylindrée Cilindrada Cilindrata Pojemność skokowa	1.0		
Valves Ventile Soupapes Válvulas Valvole Zawory	12		
Fuel type Kraftstoffart Type de carburant Tipo de combustible Tipo carburante Rodzaj paliwa	Petrol Benzin Essence Gasolina Benzina Benzyna		
Cylinder head type Bauform Zylinderkopf Forme de construction culasse Diseño culata Modello testata Konstrukcja głowicy silnika	DOHC		
Bore Bohrungsdurchmesser Diamètre de perçage Diámetro interior Diámetro foro Średnica otworu	71.0		
Cooling Kühlung Refroidissement Refrigeración Raffreddamento Układ chłodzenia	Water-cooled Wassergekühlt Refroidi par eau Rerigerado por agua Raffreddato ad acqua Chłodzony cieczą		









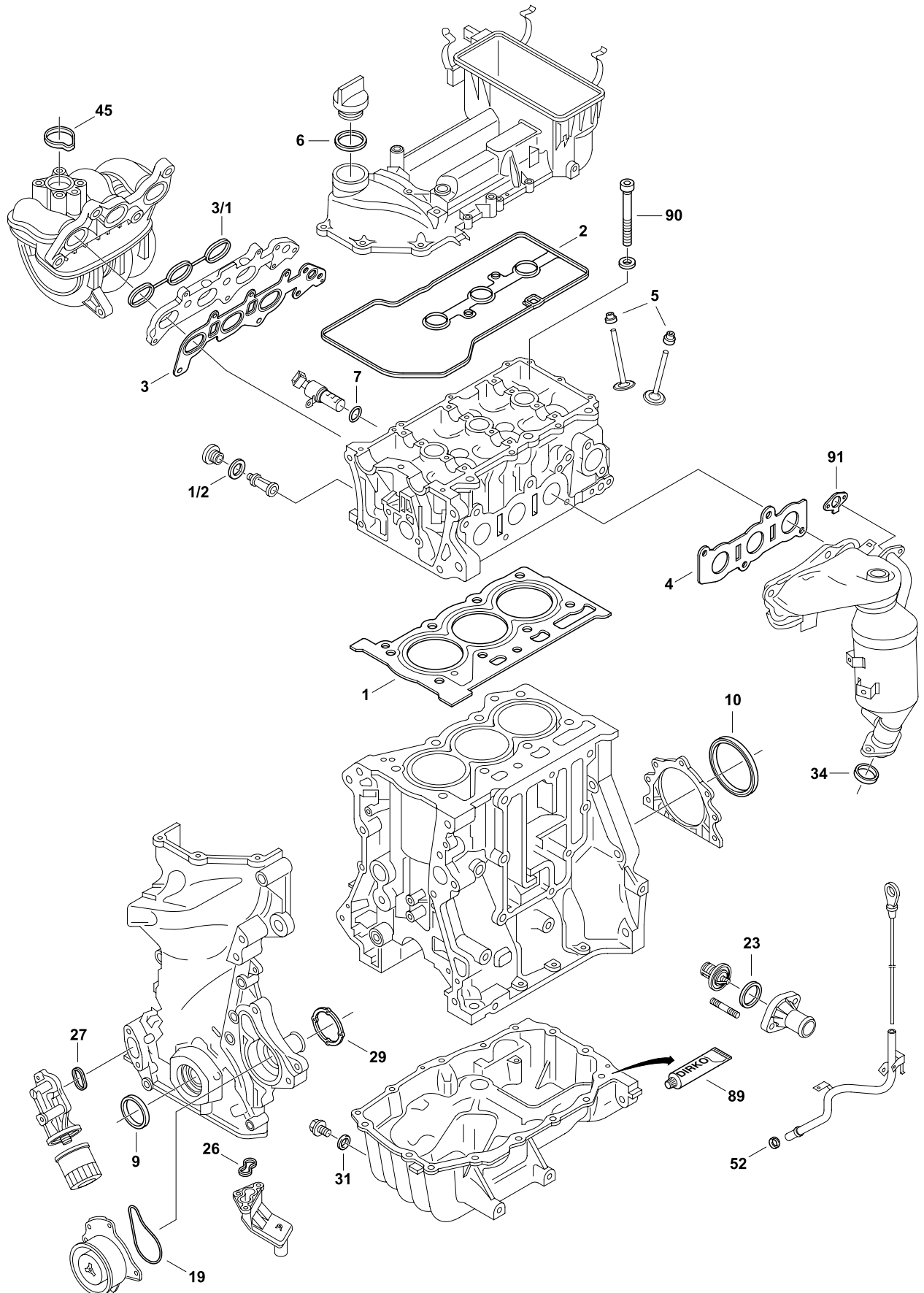

















1 CD-FTV

Cylinders Zylinder Cylindres Cilindros Cilindri Cyliny	4	AVENSIS COROLLA RAV 4 II	1999 - 2008 2000 - 2009 2001 - 2005
Capacity Hubraum Cylindrée Cilindrada Cilindrata Pojemność skokowa	2.0		
Valves Ventile Soupapes Válvulas Valvole Zawory	16		
Fuel type Kraftstoffart Type de carburant Tipo de combustible Tipo carburante Rodzaj paliwa	Diesel Diesel Diesel Gasóleo Diesel Olej napędowy		
Cylinder head type Bauform Zylinderkopf Forme de construction culasse Diseño culata Modello testata Konstrukcja głowicy silnika	DOHC		
Bore Bohrungsdurchmesser Diamètre de perçage Diámetro interior Diámetro foro Średnica otworu	82.2		
Cooling Kühlung Refroidissement Refrigeración Raffreddamento Układ chłodzenia	Water-cooled Wassergekühlt Refroidi par eau Rerigerado por agua Raffreddato ad acqua Chłodzony cieczą		









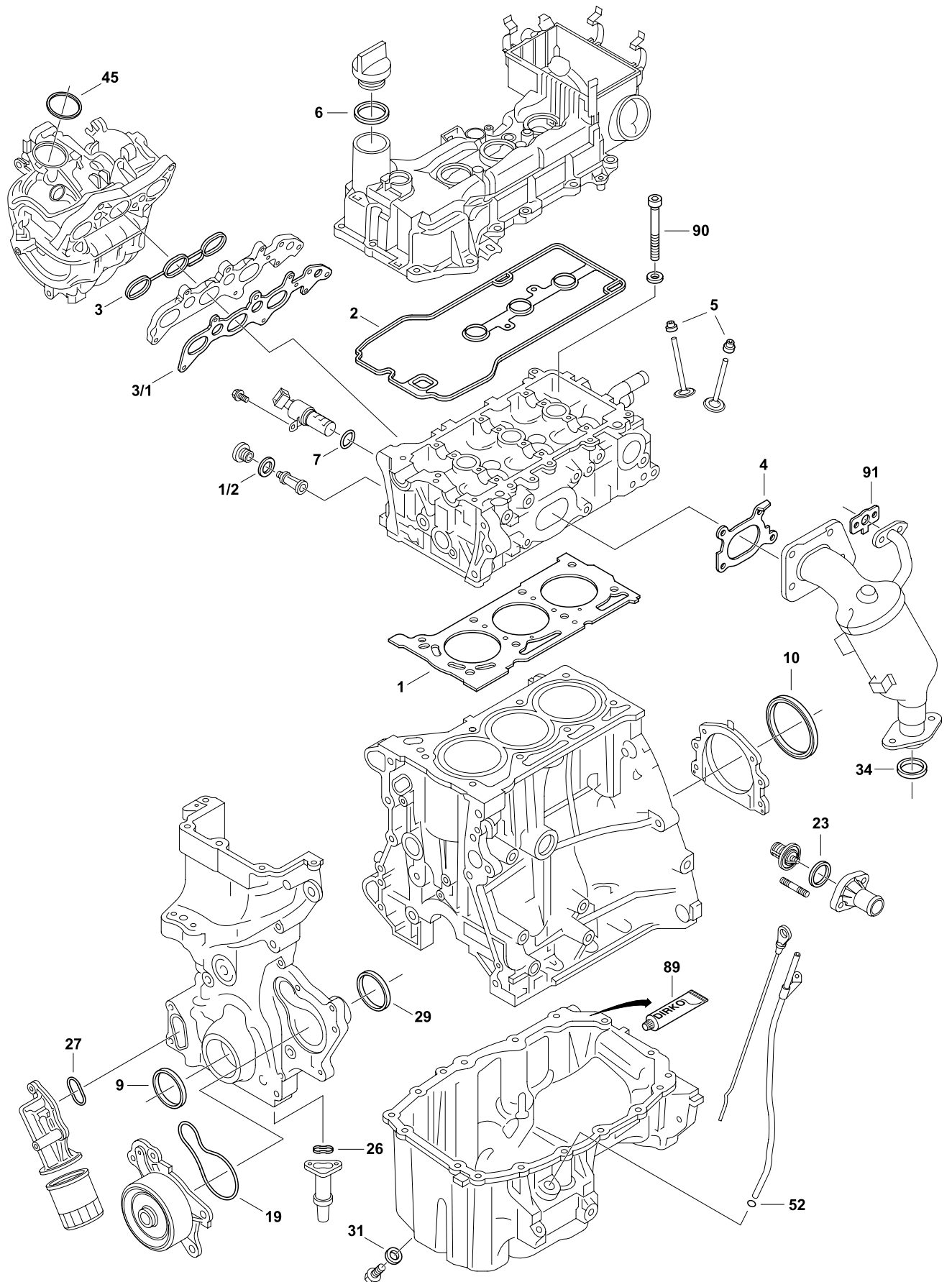



















1NR-FE

Cylinders Zylinder Cylindres Cilindros Cilindri Cyliny	4	AURIS COROLLA IQ URBAN CRUISER VERSO S YARIS	2009 - 2018 2008 - 2018 2009 - 2015 2009 - 2016 2010 - 2016 2008 -
Capacity Hubraum Cylindrée Cilindrada Cilindrata Pojemność skokowa	1.3		
Valves Ventile Soupapes Válvulas Valvole Zawory	16		
Fuel type Kraftstoffart Type de carburant Tipo de combustible Tipo carburante Rodzaj paliwa	Petrol Benzin Essence Gasolina Benzina Benzyna		
Cylinder head type Bauform Zylinderkopf Forme de construction culasse Diseño culata Modello testata Konstrukcja głowicy silnika	DOHC		
Bore Bohrungsdurchmesser Diamètre de perçage Diámetro interior Diámetro foro Średnica otworu	72.5		
Cooling Kühlung Refroidissement Refrigeración Raffreddamento Układ chłodzenia	Water-cooled Wassergekühlt Refroidi par eau Rerigerado por agua Raffreddato ad acqua Chłodzony cieczą		



			#		
	687.840	1	04111-0Q020	-	-
	687.800	1	04112-0Q020	-	-
	687.750	1	-	-	-
	338.870	1	90913-02092 90913-02093	-	-
	728.090	1	-	M9x1.5x120 	-
	877.960	1	90341-12032	M12x1.25x22	
1	484.750	1	11115-40060	Ø 72 mm ± 0.50 mm	-
1/2	114.502	1	90430-14009	14x18x1	-
2	497.380	1	11213-0Q010	-	-
3	291.530	1	17178-40020	-	-
3/1	290.930	1	17177-0Q020	HNBR	-
4	291.540	1	17173-40020	-	-
5		6	90913-02093	-	
5		6	90913-02092	-	
6		1	90430-35001	14x2.4	-
7		1	90099-14137	-	-
9	694.300	1	90311-W0013	38x50x6	-
10	848.390	1	90311-73005	73.5x89x8.5	-
19	297.020	1	16271-0Q010	-	-
23	292.260	1	16341-35010	HNBR	-
26		1	15147-40030	-	-
27		1	15691-40020	-	-
29		1	15193-40010	-	-
31	473.500	1	90430-12031	12x24x2	-
31	587.320	1	-	M12x1.25x22	-
34	293.440	1	17451-0Q010	-	-
45		1	22271-40010	-	-
52	904.860	1	96721-19010	O-Ring 10x14x2	-
89	036.164	1	-	-	 Dirko™ HT
90		8	90910-02186	M9x1.5x120 	-
91		1	25628-0Q010	-	-





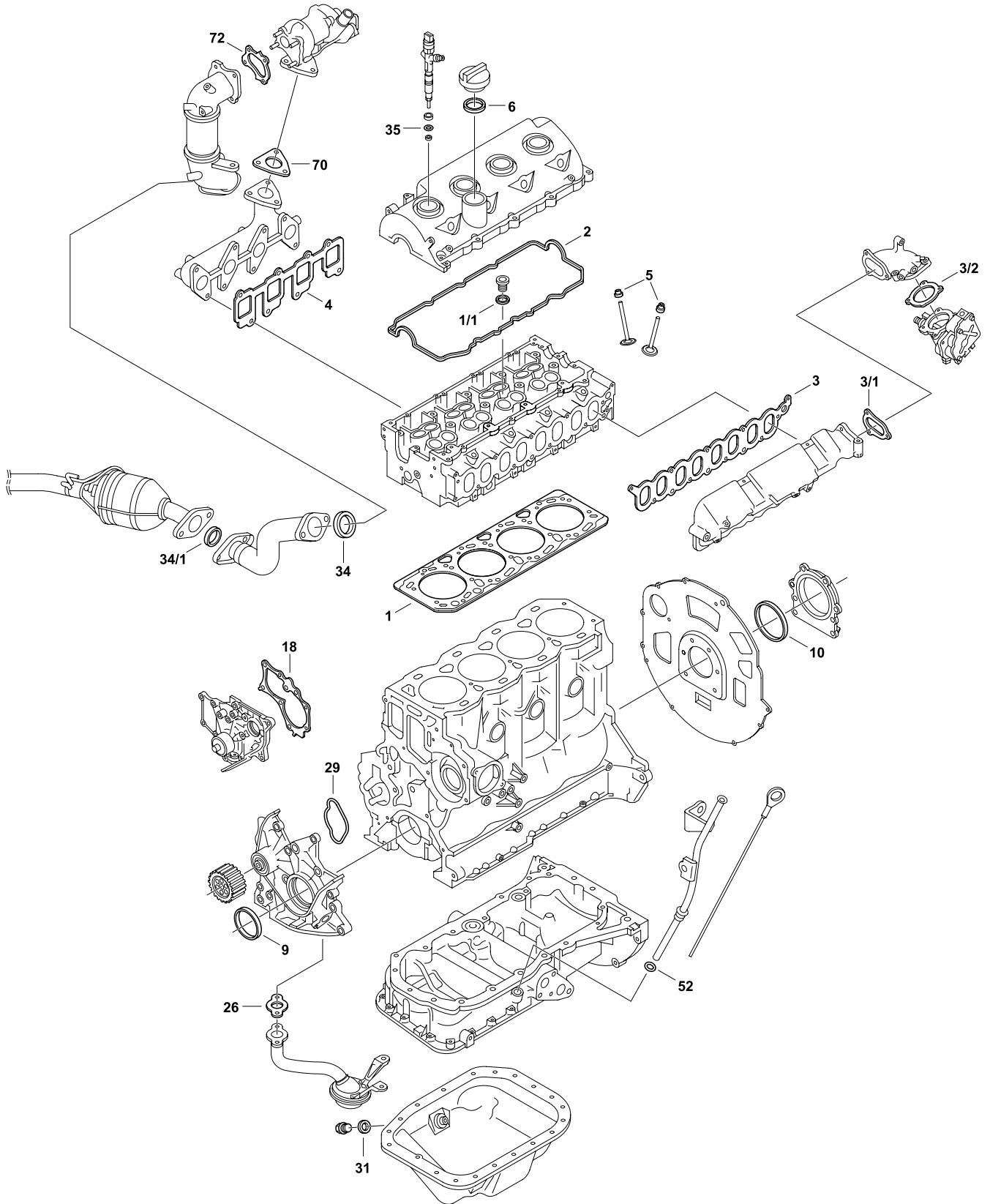



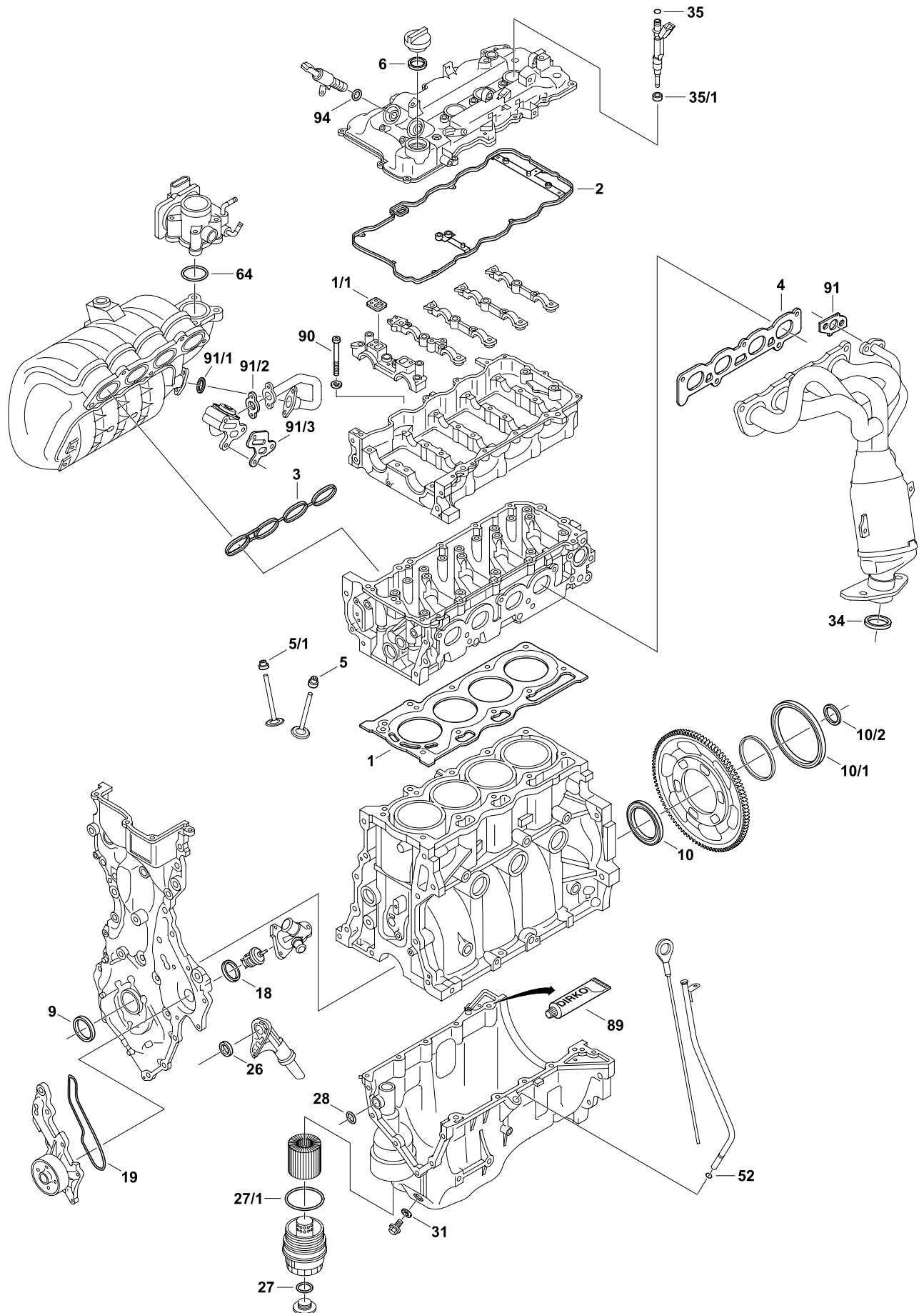



























			#	  	
	864.540	1	04111-0Q062	-	-
	694.410	1	04112-0Q061	-	-
	338.870	1	90913-02092 90913-02093	-	-
	728.090	1	-	M9x1.5x120 	-
	877.960	1	90341-12032	M12x1.25x22	
1	589.490	1	111156-40070	-	-
1/2	114.502	1	90430-14009	14x18x1	-
2	586.210	1	11213-0Q020	-	-
3	586.480	1	17177-0Q030	-	-
3/1	642.680	1	17178-0Q020	-	-
4	599.040	1	17173-40050	-	-
5		6	90913-02093	-	
5		6	90913-02092	-	
6		1	90430-35001	14x2.4	-
7		1	90099-14137	-	-
9	694.300	1	90311-W0013	38x50x6	-
10	848.390	1	90311-73005	73.5x89x8.5	-
19		1	16271-0Q020	-	-
23	292.260	1	16341-35010	HNBR	-
26		1	15147-0Q020	-	-
29		1	15193-40010	-	-
31	473.500	1	90430-12031	12x24x2	-
31	587.320	1	90341-12032	M12x1.25x22	-
34	293.440	1	17451-0Q010	-	-
45		1	22271-40010	-	-
52	904.860	1	96721-19010	O-Ring 10x14x2	-
89	036.164	1	-	-	 Dirko™ HT 
90		8	90910-02186	M9x1.5x120 	-
91		1	25628-0Q010	-	-



			#		
	478.930	1	04112-27071	-	
	459.290	1	17201-27010	-	-
	137.030	1	-	6x11/14x11	-
	374.210	1	90910-02136 90910-02139	M11x1.25x103 M11x1.25x160	-
	952.850	1	90080-43037	M12x1.25x11	
1	524.430	1	11115-27011-A0	Ø 83.0 mm $\frac{\pm}{\mu}$ 1.00 mm	1 ⊗
1	525.090	1	11115-27011-B0	Ø 83.0 mm $\frac{\pm}{\mu}$ 1.05 mm	2 ⊗
1	428.540	1	11115-27011-C0	Ø 83.0 mm $\frac{\pm}{\mu}$ 1.10 mm	3 ⊗
1	354.210	1	11115-27011-D0	Ø 83.0 mm $\frac{\pm}{\mu}$ 1.15 mm	4 ⊗
1	428.550	1	11115-27011-E0	Ø 83.0 mm $\frac{\pm}{\mu}$ 1.20 mm	5 ⊗
1/1		1	90430-14008	-	-
2	458.780	1	11213-27010	-	-
3	458.650	1	17177-27010	-	-
3/1		1	17179-27010	-	-
3/2		1	26171-27010	-	-
4	458.680	1	17173-27010	-	-
5	864.110	16	90913-02090	-	-
6		1	90430-37140	-	-
9	458.630	1	90311-45017	45x63x7	-
10	294.683	1	90311-90008	90x110x10	-
18		1	16271-27010	-	-
26		1	15149-27010	-	-
29		1	15193-27010	-	-
31	473.500	1	90430-12031	12x24x2	-
31	587.290	1	90341-12012	M12x1.25x11	-
34	481.660	1	17451-22070	-	-
34/1	474.760	1	90917-06073	55.3x74.5x4.8	-
35	982.320	1	96721-19017	17x1.90	-
52		1	96741-19010	-	-
70		1	17278-27010	-	-
72		1	17279-27010	-	-



			#	  	
	074.770	1	04111-47073	-	-
	341.210	1	04112-47032	-	-
	397.260	1	-	-	-
	215.710	1	-	-	-
	590.440	1	-	M10x1.5x126 	-
	877.960	1	90341-12032	M12x1.25x22	
1	298.410	1	11115-47050	± 0.50 mm	-
1/1		2	11159-47010	-	-
2	316.170	1	11213-47020	-	-
3	330.520	1	17177-47011	-	-
4	298.340	1	17173-47020	-	-
5	170.020	8	90913-02111	5x10/12.5x10	
5/1	215.420	8	90913-02101	5.5x10/12.5x10	
6		1	90430-35001	-	-
9	332.480	1	90311-25032	25.5x37.5x6	-
10	331.300	1	90311-99012	157.5x171.5x8	Start-Stopp-System
10/1	522.630	1	90311-99011	138x152.6x10	Start-Stopp-System
10/2		1	90301-36013	-	-
18		1	16326-47020	-	-
19		1	16271-47031	-	-
26		1	90301-22018	-	-
27		1	96723-35028	-	-
27/1		1	90301-69011	-	-
28		1	90301-19023	-	-
31	473.500	1	90430-12031	12x24x2	-
31	587.320	1	90341-12032	M12x1.25x22	-
34		2	17451-0J022	-	-
35		4	90301-07042	7.6x2	-
35/1		4	23291-23010	-	-
52		1	96741-19010	9.8x1.9	-
64		1	22271-47010	-	-
89	036.164	1	-	-	 Dirko™ HT 
90		10	90910-02174	M10x1.5x126 	-

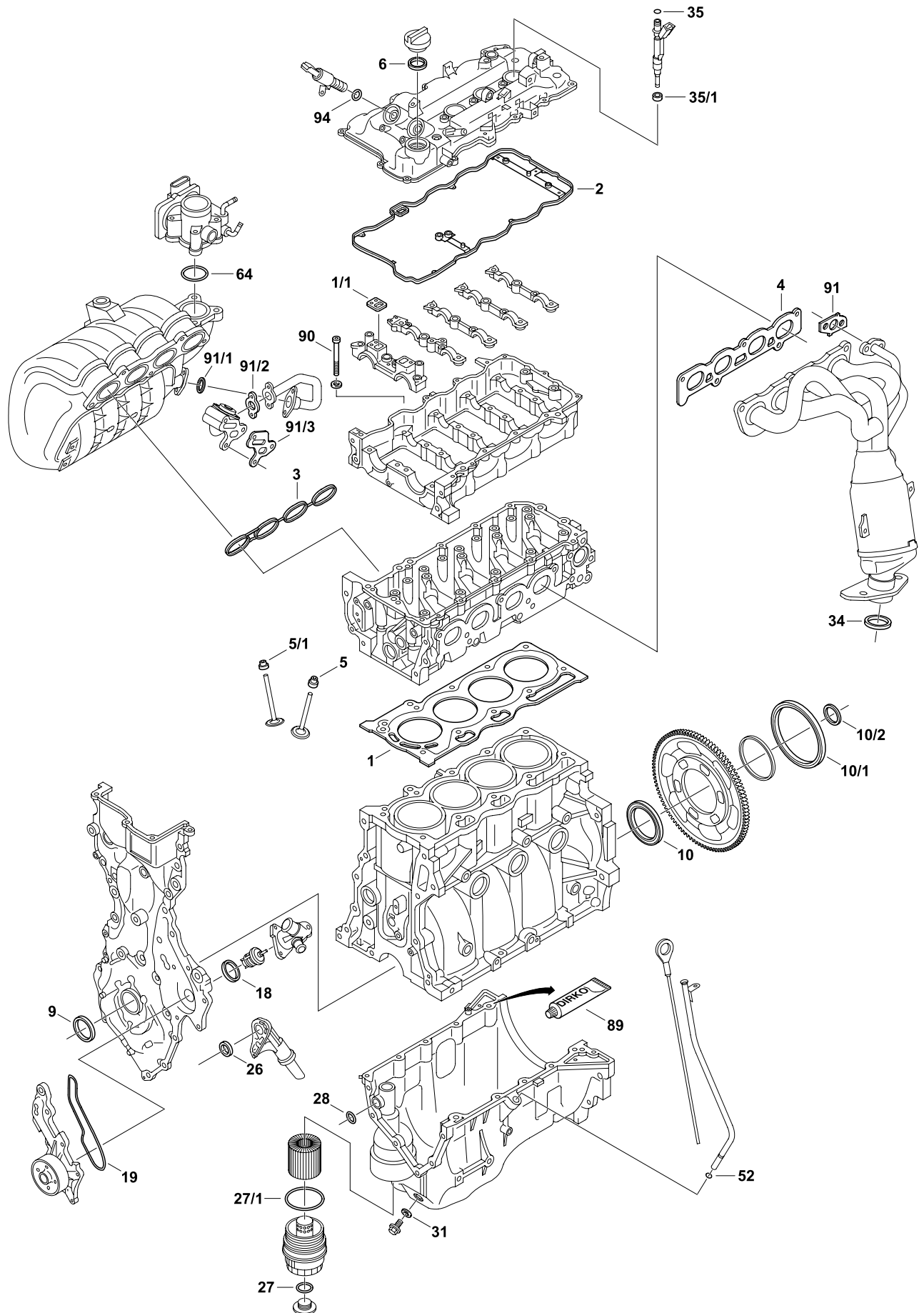









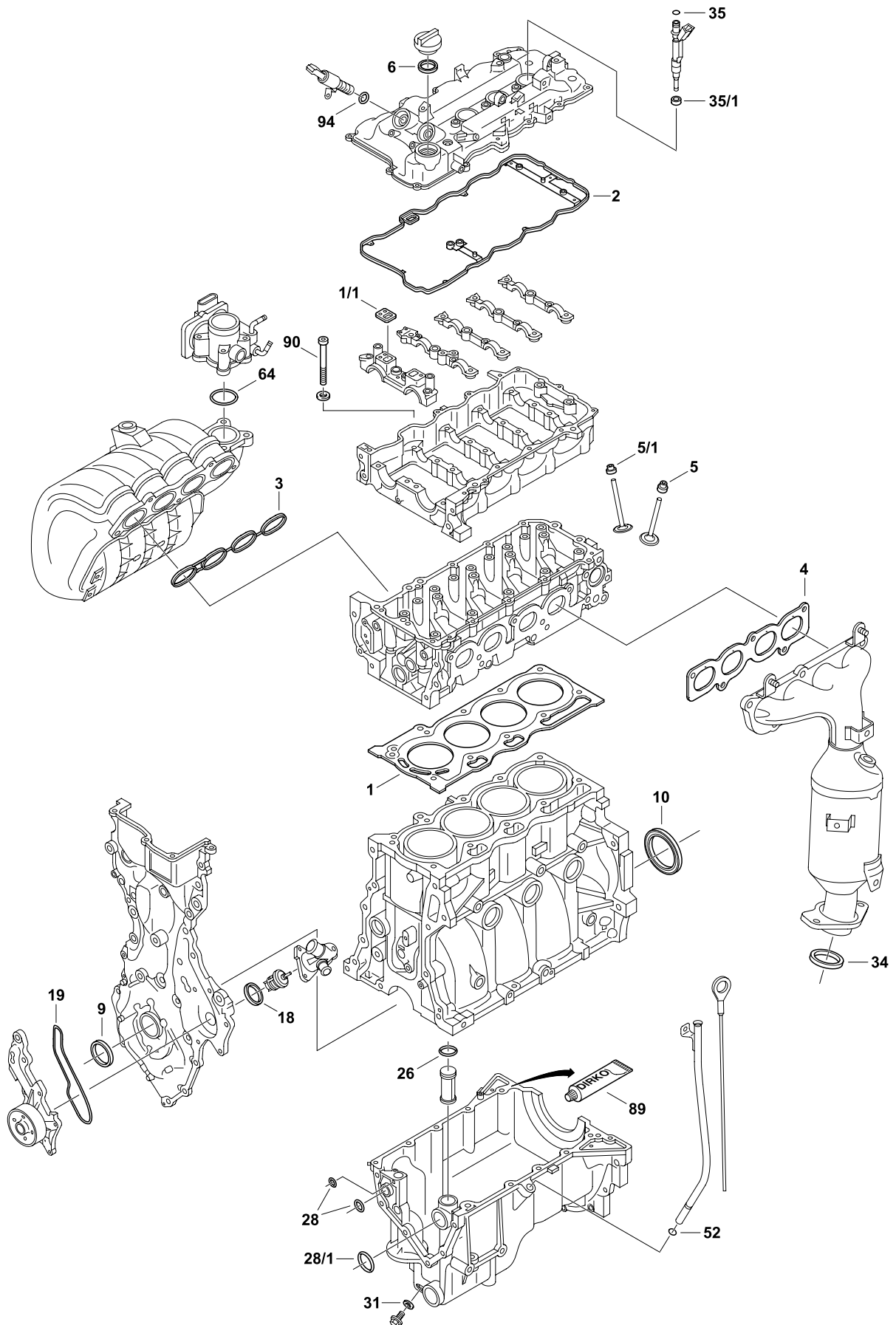









































#



91		1	25628-47010	-	-
91/1		1	25629-47010	-	-
91/2		1	25634-47010	-	-
91/3		1	25633-47010	-	-
94		2	90099-14137	14x2.4	-



			#		
	067.590	1	04111-0Y031	-	-
	067.900	1	04112-0Y031	-	-
	215.710	1	-	-	-
	590.440	1	-	M10x1.5x126 	-
	877.960	1	90341-12032	M12x1.25x22	
1	067.600	1	11115-0Y030	-	-
1/1 		2	11159-0Y030	-	-
2	316.170	1	11213-47020	-	-
3	330.520	1	17177-47011	-	-
4	067.690	1	17173-0Y060	-	-
5	170.020	8	90913-02112	5x10/12.5x10	
5/1	215.420	8	90913-02101	5.5x10/12.5x10	
6 		1	90430-37140	-	-
9	808.860	1	90311-36007	36x48x6	-
10	066.620	1	90311-T0074	78x105.5x7.5	-
18	306.360	1	16326-47020	-	-
19 		1	16271-0030	-	-
26 		1	96723-19018	30x3.5	-
28 		2	90301-19023	-	-
28/1 		1	90301-27014	-	-
31	473.500	1	90430-12031	12x24x2	-
31	587.320	1	90341-12032	M12x1.25x22	-
34 		1	17451-21070	-	-
35 		4	90301-07042	7.6x2	-
35/1 		4	23291-23010	-	-
52 		1	96741-19010	9.8x1.9	-
64 		1	22271-0Y030	-	-
89	036.164	1	-	-	 Dirko™ HT 
90 		10	90910-02174	M10x1.5x126 	-
94 		2	90099-14137	14x2.4	-

	#		
	585.250	93742687	Kalos, Lacetti, Nubira
	583.200	93740513	Kalos, Lacetti, Nubira, Rezzo
	599.210	93740202	Kalos
	176.920	–	Matiz, Tico
	585.260	–	Kalos, Lacetti, Nubira
	454.020	–	Lanos, Nubira
	711.830	–	Nexia, Racer
	584.570	–	Kalos, Lacetti, Nubira, Rezzo
	497.150	–	Kalos
	135.531	11141-78B01	Matiz, Tico
	471.740	96963220	Kalos, Lacetti, Nubira
	167.621	96103003	Lanos, Nubira, Rezzo
	068.181	96181218	Espero, Nexia
	927.930	25184663	Kalos
	550.570	96378802	Kalos, Lacetti, Nubira, Rezzo
	374.061	4 1168 2 021	Avia

F8CV

Cylinders Zylinder Cylindres Cilindros Cilindri Cylindry	3	MATIZ TICO	1998 - 1996 - 2000
Capacity Hubraum Cylindrée Cilindrada Cilindrata Pojemność skokowa	0.8		
Valves Ventile Soupapes Válvulas Valvole Zawory	6		
Fuel type Kraftstoffart Type de carburant Tipo de combustible Tipo carburante Rodzaj paliwa	Petrol/Gas Benzin/Gas Essence/Gaz Gasolina/Gas Benzina/Gas Benzyna/Gaz		
Cylinder head type Bauform Zylinderkopf Forme de construction culasse Diseño culata Modello testata Konstrukcja głowicy silnika	SOHC/OHC		
Bore Bohrungsdurchmesser Diamètre de perçage Diámetro interior Diametro foro Średnica otworu	68.5		
Cooling Kühlung Refroidissement Refrigeración Raffreddamento Układ chłodzenia	Water-cooled Wassergekühlt Refroidi par eau Refrigerado por agua Raffreddato ad acqua Chłodzony cieczą		



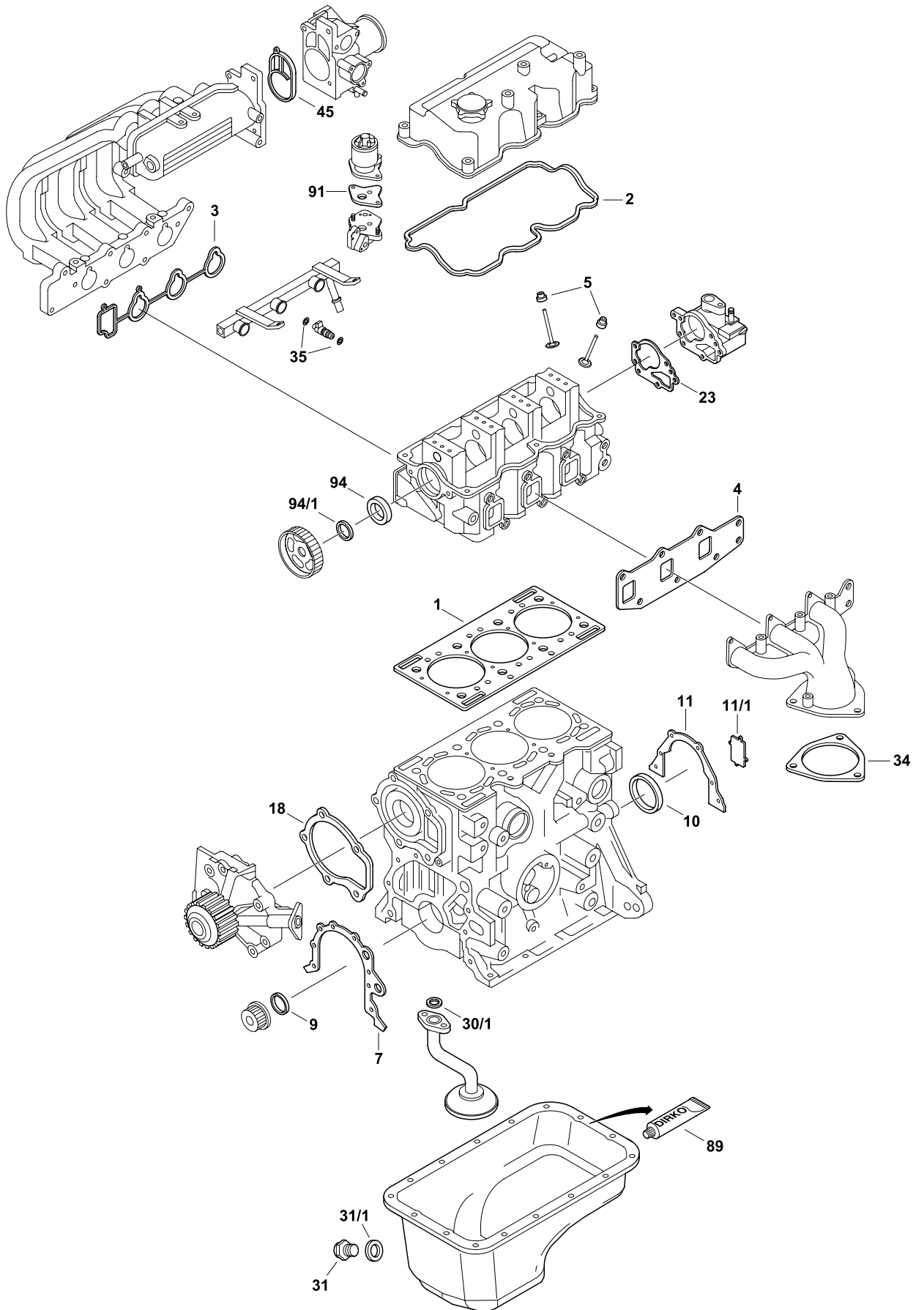



	176.920	1	-	-	-
	632.730	1	94580081	M10x1.25x97	-
	774.460	1	94580081	M14x1.5x11	-

1	135.531	1	94580082	Ø 69.5 mm ± 1.60 mm	-
2	136.271	1	94580083	-	-
3	166.210	1	96569406	-	-
4	166.240	1	96353036	-	-
5	166.190	6	94535482	5.5x9/11x9.5	-
7	B24.970	1	96353038	-	-
9	166.160	1	94535472	32x47x6	-
10	166.180	1	94535475	60x80x8	-
11	941.880	1	96353037	-	-
11/1	926.960	1	96643171	-	-
18		1	94580180	-	-
23		1	94581014	-	-
30/1		1	94535506	-	-
31	587.330	1	94535699	-	-
31/1	928.580	1	94525246	13.8x19x2.3	-
34		1	96344583	-	-
35	893.889	6	96253597	O-Ring 7.52x3.5	-
45		1	96352282	-	-
89	036.164	-	-	-	Dirko™ HT
91	497.080	1	96410115	-	-
94	166.160	1	94535472	32x47x6	-
94/1		1	94580101	-	-

	#		
	925.630	20910-2BK01	Tucson, Veloster, i30, i40, ix35 // Carens, Ceed, Pro Ceed, Soul, Sportage
	227.640	K0AH4 10 270A	H-1, H100 Pritsche, Porter Kasten, Porter Pritsche // Sorento
	855.060	20910-2GM01	Sonata, ix35 // Cerato, Magentis, Optima, Sportage
	344.760	20920-2BB01	Accent, Elantra, Veloster, i20, i30, ix20 // Carens, Ceed, Cerato, Pro Ceed, Rio, Soul, Venga
	344.750	20920-2BA00	Elantra, i30 // Ceed, Cerato, Pro Ceed
	864.470	20920-2EA00	Creta, Elantra, Sonata, Tucson, i40, ix35 // Carens, Cerato, Optima, Soul, Sportage
	508.190	20920-4AD00	Starex // Sorento
	332.450	-	Accent, Elantra, Kona, Solaris, Tucson, Veloster, i20, i30, i40, ix20, ix35 // Carens, Ceed, Cerato, Optima, Pro Ceed, Rio, Seltos, Soul, Sportage, Venga, Xceed
	933.930	22311-2B004	Accent, Elantra, Solaris, Tucson, Veloster, i20, i30, i40, ix20, ix35 // Carens, Ceed, Cerato, Pro Ceed, Rio, Seltos, Soul, Sportage, Venga
	386.330	22311-03210	i10, i20 // Picanto, Rio, Stonic
	389.600	22311-23700	Coupe, Elantra, Highway Van, Matrix, Triburon, Trajet, Tucson, i30 // Carens, Ceed, Cerato, Pro Ceed, Sportage
	442.880	22311-27411	Elantra, Santa Fe, Sonata, Trajet, Tucson, i30 // Carens, Ceed, Cerato, Magentis, Pro Ceed, Sportage
	320.980	22311-2B000	Elantra, i30 // Ceed, Cerato, Pro Ceed
	362.420	22313-2A650	Accent, Elantra, i20, i30, i40, ix20, ix35 // Carens, Ceed, Cerato, Optima, Pro Ceed, Soul, Venga
	442.890	22311-27421	Elantra, Santa Fe, Sonata, Trajet, Tucson, i30 // Carens, Ceed, Cerato, Magentis, Pro Ceed, Sportage
	451.530	22311-27870	Grandeur, Santa Fe
	481.740	22311-4A020	H-1, H100 Pritsche, Porter Kasten, Porter Pritsche // Sorento
	800.610	22311-4A120	H-1, Sorento
	451.510	22311-27860	Grandeur, Santa Fe
	473.040	22311-25013	Sonata, ix35 // Carens, Cerato, Magentis, Optima, Sportage
	442.850	22311-27401	Elantra, Santa Fe, Sonata, Trajet, Tucson, i30 // Carens, Ceed, Cerato, Magentis, Pro Ceed, Sportage
	320.990	22311-2B001	Elantra, i20, i30 // Ceed, Pro Ceed
	362.410	22311-2A650	Accent, Elantra, i20, i30, i40, ix20, ix35 // Carens, Ceed, Cerato, Optima, Pro Ceed, Soul, Sportage, Venga
	227.830	22311-4A000	H-1, H100 Pritsche, Porter Kasten, Porter Pritsche // Sorento
	800.600	22311-4A100	H-1, Sorento
	725.550	22311-02760	Atos, Getz // Picanto
	352.830	22311-03200	i10, i20
	514.150	22311-2F120	Grand Santa Fe, Grandeur, Santa Fe, Staria Bus // Carnival, Grand Carnival, Sorento
	481.730	22311-4A010	H-1, H100 Pritsche, Porter Kasten, Porter Pritsche // Sorento
	720.950	22311-26603	Accent, Getz // Rio

G4FA			
Cylinders Zylinder Cylindres Cilindros Cilindri Cyldry	4		
Capacity Hubraum Cylindrée Cilindrada Cilindrata Pojemność skokowa	1.4		
Valves Ventile Soupapes Válvulas Valvole Zawory	16		
Fuel type Kraftstoffart Type de carburant Tipo de combustible Tipo carburante Rodzaj paliwa	Petrol/Gas Benzin/Gas Essence/Gaz Gasolina/Gas Benzina/Gas Benzyna/Gaz	ACCENT IV i20 i30 ix20 CEE'D PRO CEE'D RIO III VENGA	2010 - 2017 2008 - 2015 2007 - 2010 - 2019 2006 - 2018 2008 - 2018 2011 - 2017 2010 -
Cylinder head type Bauform Zylinderkopf Forme de construction culasse Diseño culata Modello testata Konstrukcja głowicy silnika	DOHC		
Bore Bohrungsdurchmesser Diamètre de perçage Diámetro interior Diametro foro Średnica otworu	77.0		
Cooling Kühlung Refroidissement Refrigeración Raffreddamento Układ chłodzenia	Water-cooled Wassergekühlt Refroidi par eau Rerigerado por agua Raffreddato ad acqua Chłodzony cieczą		

G4FC			
Cylinders Zylinder Cylindres Cilindros Cilindri Cyldry	4		
Capacity Hubraum Cylindrée Cilindrada Cilindrata Pojemność skokowa	1.6		
Valves Ventile Soupapes Válvulas Valvole Zawory	16		
Fuel type Kraftstoffart Type de carburant Tipo de combustible Tipo carburante Rodzaj paliwa	Petrol Benzin Essence Gasolina Benzina Benzyna	ACCENT IV ELANTRA IV i20 i30 ix20 VELOSTER CARENS III CEE'D CERATO PRO CEE'D RIO SOUL VENGA	2010 - 2006 - 2011 2008 - 2012 2007 - 2010 - 2019 2011 - 2017 2009 - 2006 - 2018 2006 - 2008 - 2013 2012 - 2017 2009 - 2014 2010 -
Cylinder head type Bauform Zylinderkopf Forme de construction culasse Diseño culata Modello testata Konstrukcja głowicy silnika	DOHC		
Bore Bohrungsdurchmesser Diamètre de perçage Diámetro interior Diametro foro Średnica otworu	77.0		
Cooling Kühlung Refroidissement Refrigeración Raffreddamento Układ chłodzenia	Water-cooled Wassergekühlt Refroidi par eau Rerigerado por agua Raffreddato ad acqua Chłodzony cieczą		

G4FD			
Cylinders Zylinder Cylindres Cilindros Cilindri Cyldry	4		
Capacity Hubraum Cylindrée Cilindrada Cilindrata Pojemność skokowa	1.6		
Valves Ventile Soupapes Válvulas Valvole Zawory	16		
Fuel type Kraftstoffart Type de carburant Tipo de combustible Tipo carburante Rodzaj paliwa	Petrol Benzin Essence Gasolina Benzina Benzyna	i30 i40 I ix35 TUCSON VELOSTER CARENS IV CEE'D PRO CEE'D SOUL SPORTAGE III SPORTAGE IV	2011 - 2016 2011 - 2019 2010 - 2015 2015 - 2020 2011 - 2017 2013 - 2012 - 2018 2013 - 2018 2011 - 2018 2011 - 2015 - 2022
Cylinder head type Bauform Zylinderkopf Forme de construction culasse Diseño culata Modello testata Konstrukcja głowicy silnika	DOHC		
Bore Bohrungsdurchmesser Diamètre de perçage Diámetro interior Diametro foro Średnica otworu	77.0		
Cooling Kühlung Refroidissement Refrigeración Raffreddamento Układ chłodzenia	Water-cooled Wassergekühlt Refroidi par eau Rerigerado por agua Raffreddato ad acqua Chłodzony cieczą		

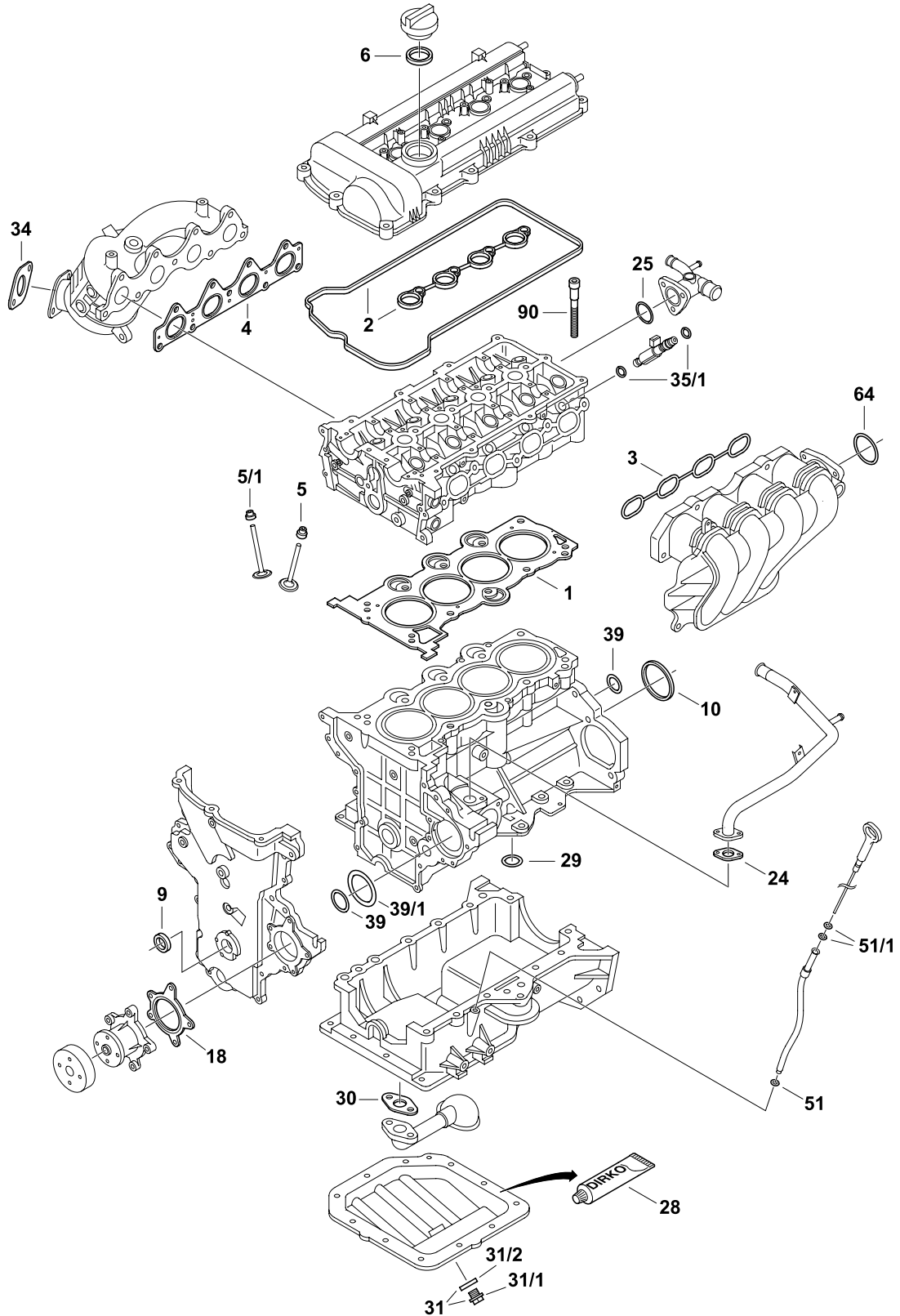



	877.170	1	20910-2BA00 20910-2BC00	-	-	-> 11/2008
	877.191	1	20910-2BG00/02 20910-2BB00/01 20910-2BU03	-	-	01/2009 ->
	344.750	1	20920-2BA00	-	-	-> 11/2008
	344.761	1	20920-2BG00/02 20910-2BB00/01 20920-2BU03	-	-	01/2009 ->
	332.450	1	-	-	-	-
	711.330	1	-	M9x1.5x144	-	-> 2011
	711.530	1	-	M10x1.5x144	-	2011 ->

1	320.980	1	22311-2B000	Ø 78.5 mm ± 0.50 mm	-	-> 11/2008
1	320.990	1	22311-2B001	Ø 78.5 mm ± 0.50 mm	-	11/2008 -> 01/2009
1	933.930	1	22311-2B003	Ø 78.5 mm ± 0.50 mm	-	-> 01/2009
2	329.910	1	22441-2B002	-	-	Kit
3	310.560	1	28411-2B000 28411-2B500	-	-	-
4	308.220	1	28521-2B010	-	-	-
5	342.000	8	22224-2B010	5.5x9.8/12.9x12	-	-
5/1	330.310	8	22224-2B000	5.5x9.8/12.9x12	-	-
6		1	26502-22600	-	-	-
9	323.630	1	21421-2B000	26x37.5x6	-	-
10	318.360	1	21443-2B000	76x108x8	-	-
18	316.180	1	25124-2B000	-	-	-
24		1	25452-2B000	-	-	-
25		1	25623-2B000	-	-	-
28	036.164	1	-	-	-	Dirko™ HT
29		1	21144-2B000	22x2.4	-	-
30		1	26259-2B000	-	-	-
31	523.500	1	-	M14x1.5x15	-	Kit
31/1	523.480	1	21512-23000	M14x1.5x15	-	-
31/2	726.760	1	21513-23001	14x20x2	-	-
34	316.150	1	28751-2H000 28751-2V000	-	-	-
35/1		8	35312-22000	-	-	-
39		2	17512-22000	22.5x31.75x1	-	-
39/1		2	21142-2B000	-	-	-
51	212.610	1	26614-2B000	9x2	-	-
51/1		2	26615-2B000	7.1x1.8	-	-
64		1	28312-2B000	-	-	-
64		1	28313-2B300	-	-	-
90		10	22321-2B000	-	-	-> 2011
90		10	22321-2B700	-	-	2011 ->

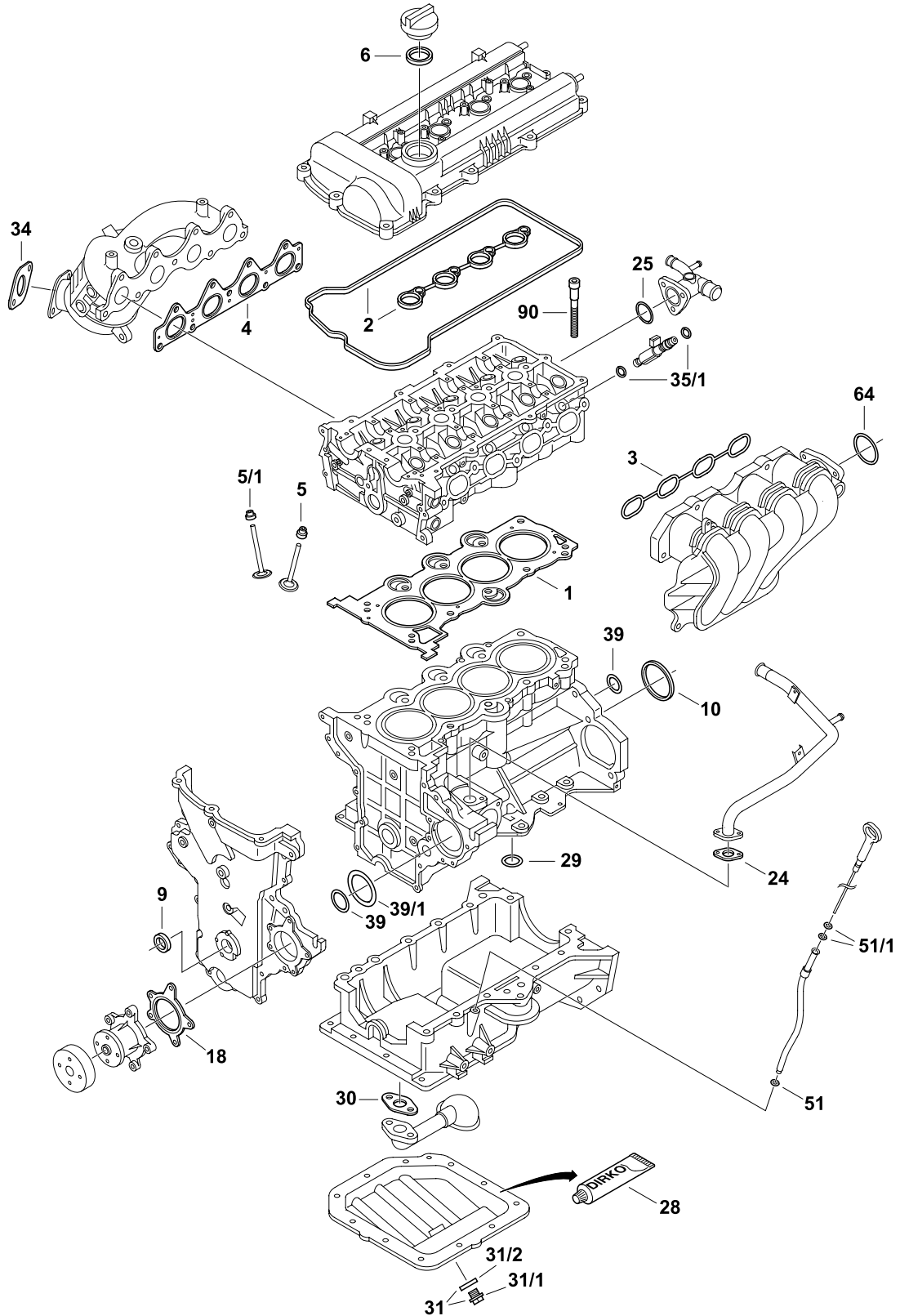



	877.170	1	20910-2BA00 20910-2BC00	-	-> 11/2008
	877.191	1	20910-2BG00/02 20910-2BB00/01 20910-2BU03	-	01/2009 ->
	344.750	1	20920-2BA00	-	-> 11/2008
	344.761	1	20920-2BG00/02 20910-2BB00/01 20920-2BU03	-	01/2009 ->
	332.450	1	-	-	-
	711.330	1	-	M9x1.5x144	-> 2011
	711.530	1	-	M10x1.5x144	2011 ->
	329.910	1	22441-2B002	-	Kit
1	320.980	1	22311-2B000	Ø 78.5 mm ± 0.50 mm	-> 11/2008
1	320.990	1	22311-2B001	Ø 78.5 mm ± 0.50 mm	11/2008 -> 01/2009
1	933.930	1	22311-2B003	Ø 78.5 mm ± 0.50 mm	-> 01/2009
2	547.460	1	22441-2B800 22441-2B801	-	-
3	310.560	1	28411-2B000 28411-2B500	-	-
4	308.220	1	28521-2B010	-	-
5	342.000	8	22224-2B010	5.5x9.8/12.9x12	-
5/1	330.310	8	22224-2B000	5.5x9.8/12.9x12	-
6		1	26502-22600	-	-
9	323.630	1	21421-2B000	26x37.5x6	-
10	318.360	1	21443-2B000	76x108x8	-
18	316.180	1	25124-2B000	-	-
24		1	25452-2B000	-	-
25		1	25623-2B000	-	-
28	036.164	1	-	-	Dirko™ HT
29		1	21144-2B000	22x2.4	-
30		1	26259-2B000	-	-
31	523.500	1	-	M14x1.5x15	Kit
31/1	523.480	1	21512-23000	M14x1.5x15	-
31/2	726.760	1	21513-23001	14x20x2	-
34	589.460	2	28751-2B200 28751-1R000	Ø 62 mm	-

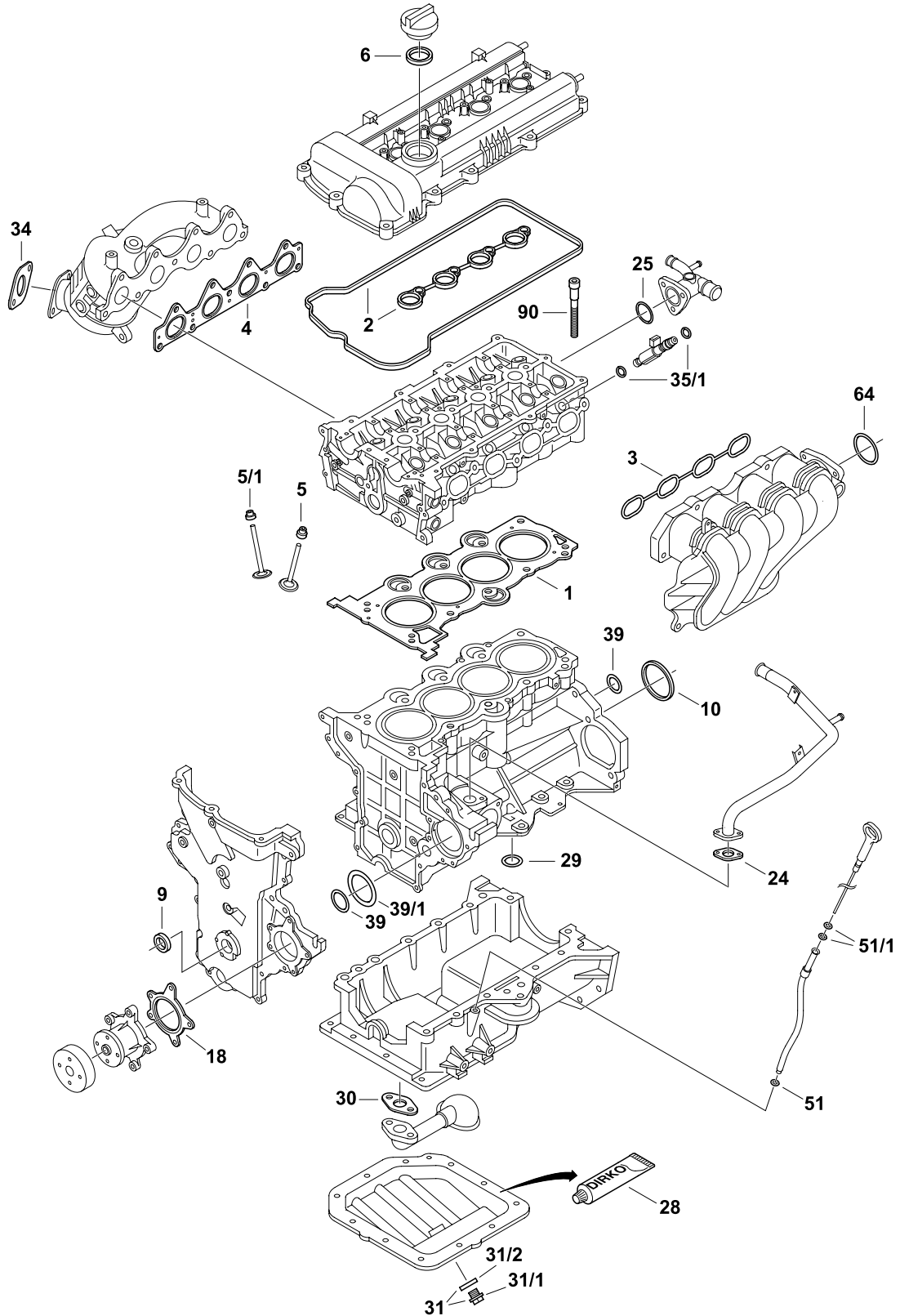



			#				
35/1		8	35312-22000	-			-
39		2	17512-22000	22.5x31.75x1			-
39/1		2	21142-2B000	-			-
51	212.610	1	26614-2B000	9x2			-
51/1		2	26615-2B000	7.1x1.8			-
64		1	28312-2B000	-			-
64		1	28313-2B300	-			-
90		10	22321-2B000	-			-> 2011
90		10	22321-2B700	-			2011 ->

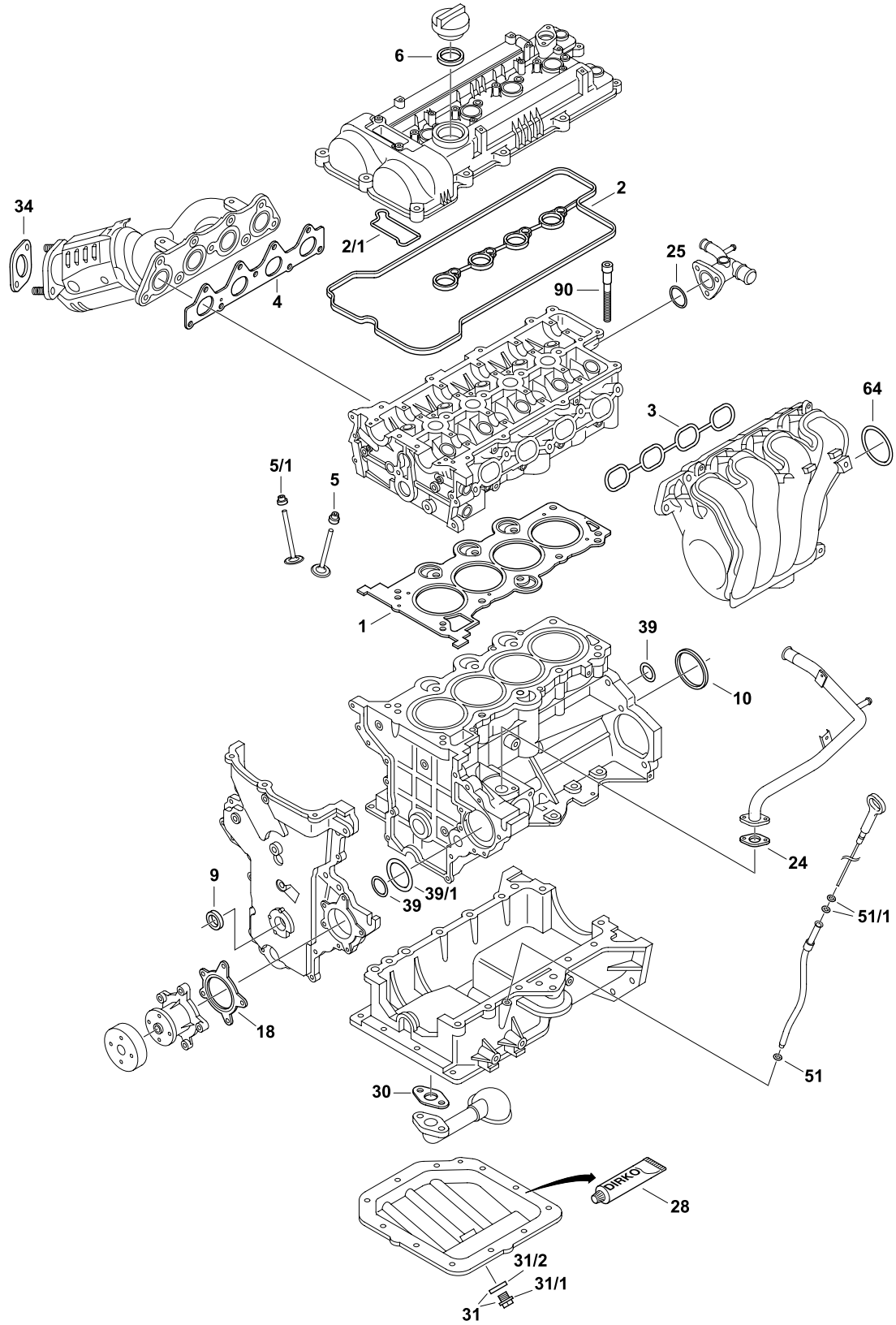



	925.630	1	20910-2BK01 20910-2BB03	-	-
	925.610	1	20920-2BK01 20920-2BH02 20920-2BB03 20920-2BK00	-	-
	332.450	1	-	-	-
	523.500	1	21512-21000 21512-23000	M14x1.5x15	Kit
	711.530	1	-	M10x1.5x144	-
1	933.930	1	22311-2B003 22311-2B004	Ø 78.5 mm ± 0.50 mm	-
2	650.350	1	22441-2B610	-	-
2/1		1	22443-2B600	-	-
3	705.040	1	28411-2B600	-	-
4	308.220	1	28521-2B400	-	-
5	342.000	8	22224-2B010	5.5x9.8/12.9x12	-
5/1	330.310	8	22224-2B001	5.5x9.8/12.9x12	-
6		1	26502-22600	-	-
9	323.630	1	21421-2B030	26x37.5x6	-
10	318.360	1	21443-2B020	76x108x8	-
18	316.180	1	25124-2B000	-	-
24		1	25452-2B000	-	-
25		1	25623-2B000	-	-
28	036.164	1	-	-	Dirko™ HT
30		1	26259-2B000	-	-
31	523.500	1	-	M14x1.5x15	Kit
31/1	523.480	1	21512-23000	M14x1.5x15	-
31/2	726.760	1	21513-23001	14x20x2	-
34	589.460	1	28751-2B200	Ø 62 mm	-
39		2	17512-22000	22.5x31.75x1	-
39/1		2	21142-2B000	-	-
51	212.610	1	26614-35020	9x2	-
51/1		2	26615-2B000	7.1x1.8	-
64		1	28313-2B600	-	-
90		10	22321-2B700	-	-

Social Media





Website



Newsletter



Online Catalog



Service Information



Instagram



WeChat



Facebook



1. Exclusion of liability

All information in this catalog has been carefully prepared by us. We accept no liability for the accuracy and completeness of data contained in this catalog. Any claim of damages against us arising from the use of the data contained in the catalog, or the use of any erroneous or incomplete data, is excluded. Subject to technical developments and changes. Before installing any replacement parts named in this catalog, it must be checked whether the parts are suitable for the intended purpose. Our technical service department is available for this at any time. In case of doubt, seek clarification. We expressly give notice that all replacement parts must be installed by trained, qualified personnel.

2. Notification of copyright and trademark law

The copyright for texts, graphics, and image documents created by us remains ours. Any imitation, reproduction, or use of such objects in other printed or electronic publications requires our written permission and citation of the source.

3. Terms and conditions

We give express notice that delivery is made exclusively under our general terms and conditions. The current edition of our general sales and delivery conditions is available on our Internet site, at: www.elring.de/agb_en. We will be happy to send them to you upon request.

4. Miscellaneous

Names, descriptions, and numbers of vehicles and manufacturers and the like are intended solely for internal comparison purposes. The same applies to original spare part numbers from the vehicle and engine manufacturers. They are not an indication of origin and must not be used with vehicle owners.

Previous editions become obsolete with the publication of this catalog.

1. Haftungsausschluss

Sämtliche Angaben in diesem Katalog wurden von uns sorgfältig und fundiert bearbeitet. Wir übernehmen für die Richtigkeit und Vollständigkeit der im Katalog enthaltenen Angaben keine Gewähr. Sämtliche Ersatzansprüche gegen uns, die durch die Nutzung der im Katalog enthaltenen Angaben bzw. durch die Nutzung eventuell fehlerhafter oder unvollständiger Angaben verursacht wurden, sind ausgeschlossen. Laufende technische Entwicklungen oder Änderungen bleiben vorbehalten. Vor dem Einbau der in diesem Katalog genannten Ersatzteile ist zu prüfen, ob die Teile für den geplanten Verwendungszweck geeignet sind. Hierfür steht unser technischer Kundendienst jederzeit zur Verfügung. In allen Zweifelsfällen sollte Rücksprache erfolgen. Wir weisen ausdrücklich darauf hin, dass alle Ersatzteile von geschultem Fachpersonal eingebaut werden müssen.

2. Hinweise zum Urheber- und Kennzeichnungsrecht

Das Urheberrecht für die von uns erstellten Texte, Grafiken und Bilddokumente bleibt allein bei uns. Eine Nachahmung, Vervielfältigung oder Verwendung solcher Objekte in anderen gedruckten oder elektronischen Publikationen ist nur mit unserer schriftlichen Genehmigung und mit Quellenangabe gestattet.

3. AGB

Wir weisen ausdrücklich darauf hin, dass Lieferungen ausschließlich zu unseren Allgemeinen Verkaufs- und Lieferbedingungen erfolgen. Die aktuelle Fassung unserer Allgemeinen Verkaufs- und Lieferbedingungen ist auf unserer Internetseite unter: www.elring.de/agb_de veröffentlicht. Auf Wunsch senden wir Ihnen diese auch gerne zu.

4. Sonstiges

Namen, Beschreibungen, Nummern von Fahrzeugen und Herstellern und Ähnliches sind ausschließlich zu internen Vergleichszwecken bestimmt. Gleiches gilt für Original-Ersatzteilnummern der Fahrzeug- und Motorenhersteller. Sie sind keine Herkunftsbezeichnung und dürfen Fahrzeugbesitzern gegenüber nicht verwendet werden.

Mit Erscheinen dieses Katalogs verlieren frühere Ausgaben ihre Gültigkeit.

1. Limitation de responsabilité

Nous avons apporté le plus grand soin à la rédaction et à la vérification des informations figurant dans ce catalogue. Toutefois, nous ne pouvons garantir de manière absolue l'exactitude et l'intégrité des informations fournies. En conséquence, nous ne pouvons en aucun cas être tenus responsables de tout préjudice résultant de l'utilisation des informations de ce catalogue ou de l'utilisation d'une information erronée ou incomplète. Nous nous réservons le droit de modifier ou d'adapter nos produits aux évolutions technologiques. Avant de procéder au montage des pièces de rechange citées dans ce catalogue, vérifiez si celles-ci sont adaptées à l'utilisation prévue. Notre service clientèle est à votre disposition pour tout renseignement à ce sujet. En cas de doute, il est fortement recommandé de lui demander conseil. Nous vous avisons explicitement que tout remplacement de pièce doit impérativement être effectué par des techniciens spécialisés.

2. Propriété intellectuelle et propriété industrielle

Tous les textes, graphismes et éléments visuels créés par nous nous sont réservés au titre de la propriété industrielle. A ce titre, toute reproduction, adaptation ou utilisation, totale ou partielle, sur un support papier ou informatique, ne pourra être faite sans notre autorisation écrite et sans citation explicite de la source.

3. CGV

Nous vous avisons explicitement que les présentes conditions générales de vente sont les seules applicables aux produits et services fournis par notre société. La version actuellement en vigueur de nos conditions générales de vente est disponible sur notre site Internet : www.elring.de/agb_en. Celles-ci peuvent vous être envoyées par courrier sur simple demande.

4. Dispositions diverses

Les noms, descriptifs, numéros de véhicules et de constructeurs et autres références sont mentionnés à des fins exclusives de comparaison en interne. Ceci concerne également les numéros des pièces de rechange d'origine des constructeurs automobiles et motoristes. Ces numéros ne constituent pas une indication d'origine et ne doivent pas être utilisés à l'endroit des propriétaires des véhicules. Ce catalogue remplace et annule les éditions précédentes.



www.elring.com

1. Exención de responsabilidad

Todos los datos de este catálogo han sido elaborados de manera cuidadosa y fundamentada. La empresa no se responsabiliza por la corrección ni por la exhaustividad de los datos incluidos en el catálogo. No se admiten reclamaciones de indemnización derivadas del uso de datos incluidos en este catálogo o provocadas por la presencia de datos ocasionalmente erróneos o incompletos. La empresa se reserva el derecho de introducir modificaciones y mejoras técnicas. Antes de montar las piezas de recambio mencionadas en este catálogo, es necesario verificar si las piezas son adecuadas para el uso previsto. Nuestro servicio técnico de atención al cliente está siempre a su disposición. En caso de duda, debe realizarse la consulta correspondiente. Se hace constar expresamente que todas las piezas de recambio deben ser montadas por personal técnico cualificado.

2. Notas de copyright y derechos de autor

Los derechos de autor correspondientes a textos, gráficos e imágenes elaborados por la empresa son propiedad exclusiva de la empresa. La copia, reproducción o utilización de dichos elementos en otras publicaciones impresas o electrónicas sólo están permitidas si existe una autorización por escrito de la empresa y se menciona la fuente.

3. Condiciones Generales

Se hace constar expresamente que las entregas sólo tienen lugar en el marco de nuestras Condiciones Generales de Venta y Suministro. La versión vigente de las Condiciones Generales de Venta y Suministro está publicada en nuestro sitio de Internet en la dirección: www.elring.de/agb_en. Si lo desea, podemos enviarle un ejemplar.

4. Otros

Los nombres, las descripciones, los números de vehículos y fabricantes y similares se utilizan exclusivamente con fines comparativos a nivel interno. Lo mismo es válido para los números de piezas de recambio originales de los fabricantes de vehículos y motores. No son denominaciones de origen y no deben utilizarse ante los propietarios de los vehículos.

Con la aparición de este catálogo pierden su validez las versiones anteriores.

1. Esclusione di responsabilità

Tutti i dati riportati nel presente catalogo sono stati da noi accuratamente elaborati su basi fondate. Non forniamo alcuna garanzia riguardo all'esattezza e alla completezza dei dati riportati nel catalogo. È escluso qualsiasi diritto di rimborso nei nostri confronti, qualora sia dovuto all'applicazione dei dati contenuti nel catalogo, ovvero all'applicazione di eventuali dati errati o incompleti. Ci riserviamo di apportare eventuali modifiche o di adeguarci agli sviluppi tecnologici in corso. Prima di montare i pezzi di ricambio riportati nel presente catalogo, occorre verificare se i pezzi sono adeguati agli scopi d'utilizzo previsti. Il nostro servizio clienti per problematiche tecniche è a vostra completa disposizione. In caso di dubbio, rivolgersi sempre al servizio competente. Facciamo espressamente notare che tutti i pezzi di ricambio devono essere montati da personale tecnico qualificato.

2. Avvertenze sui diritti d'autore e sul diritto ad apporre il contrassegno

I diritti d'autore per i testi, i grafici e i documenti fotografici da noi prodotti sono di nostro esclusivo appannaggio. L'imitazione, la riproduzione o l'utilizzo di tali oggetti in altre pubblicazioni stampate o elettroniche sono consentite esclusivamente previa nostra autorizzazione scritta e con citazione della fonte.

3. CG

Facciamo espressamente notare che le spedizioni avvengono esclusivamente alle nostre condizioni generali di fornitura e di vendita. La versione attuale delle nostre condizioni generali di fornitura e di vendita può essere consultata sulla nostra pagina web: www.elring.de/agb_en. Su richiesta, saremo lieti di inviarvene una copia.

4. Varie

Nomi, descrizioni, numeri di veicoli e produttori, nonché altri dati analoghi sono destinati ai soli scopi comparativi interni. Lo stesso vale per i numeri dei pezzi di ricambio originali del produttore dei motori e del veicolo. Essi non presentano alcuna indicazione di origine e non devono essere utilizzati da parte del proprietario del veicolo. Con la pubblicazione del presente catalogo, le edizioni precedenti non sono più valide.

1. Wykluczenie odpowiedzialności

Wszystkie informacje przedstawione w niniejszym katalogu zostały przez nas opracowane z należytą starannością i dokładnością. Nie ponosimy odpowiedzialności za prawdziwość i kompletność informacji zawartych w katalogu. Wszelkie roszczenia wobec nas, których podstawę stanowi skorzystanie z zawartych w katalogu informacji lub skorzystanie z nieprawidłowych lub niekompletnych informacji, są wykluczone. Aktualny rozwój techniczny i zmiany są zastrzeżone. Przed przystąpieniem do montażu części zamiennych wymienionych w niniejszym katalogu należy sprawdzić, czy te części nadają się do planowanego celu zastosowania. W tym zakresie można się zwrócić w dowolnym momencie do naszego działu technicznego. Kontakt jest zalecany w razie jakichkolwiek wątpliwości. Wyraźnie podkreślamy, że wszystkie części zamienne muszą być montowane przez wykwalifikowany personel specjalistyczny.

2. Informacje dot. prawa autorskiego i etykietowania

Prawa autorskie do opracowanych przez nas tekstów, grafik i dokumentów graficznych przysługują wyłącznie nam. Kopiowanie, powielanie lub wykorzystywanie tego typu obiektów w innych publikacjach drukowanych lub elektronicznych jest dozwolone wyłącznie po uzyskaniu naszej pisemnej zgody i podaniu źródła.

3. OWH

Wyraźnie podkreślamy, że wszelkie dostawy odbywają się wyłącznie w oparciu o nasze Ogólne warunki sprzedaży i dostaw. Aktualna wersja naszych Ogólnych warunków sprzedaży i dostaw jest dostępna na stronie internetowej: www.elring.de/agb_de. Na żądanie możemy je także przesłać.

4. Inne

Nazwy, opisy, numery pojazdów i producentów itp. są przeznaczone wyłącznie do użytku wewnętrznego w celu porównania. To samo dotyczy oryginalnych numerów części zamiennych producentów pojazdów i silników. Nie stanowią one definicji pochodzenia i nie można ich stosować w odniesieniu do właścicieli pojazdów. Wraz z publikacją niniejszego katalogu tracą ważność wydania wcześniejsze.



We are not liable for printing errors. Keine Gewähr bei Druckfehlern. Toute garantie exclue pour les fautes d'impression. Se declina toda responsabilidad por erratas de imprenta. Si declina ogni responsabilità per eventuali errori di stampa. Zastrzegamy sobie prawo do błędów w druku.

ElringKlinger AG | Aftermarket Division
Max-Eyth-Straße 2 | 72581 Dettingen/Erms | Germany
Phone +49 7123 724-799 | Fax +49 7123 724-798
service@elring.com | www.elring.com

C510303 1.123 EN DE FR ES IT PL

